

LAUNDRY COLLECTION

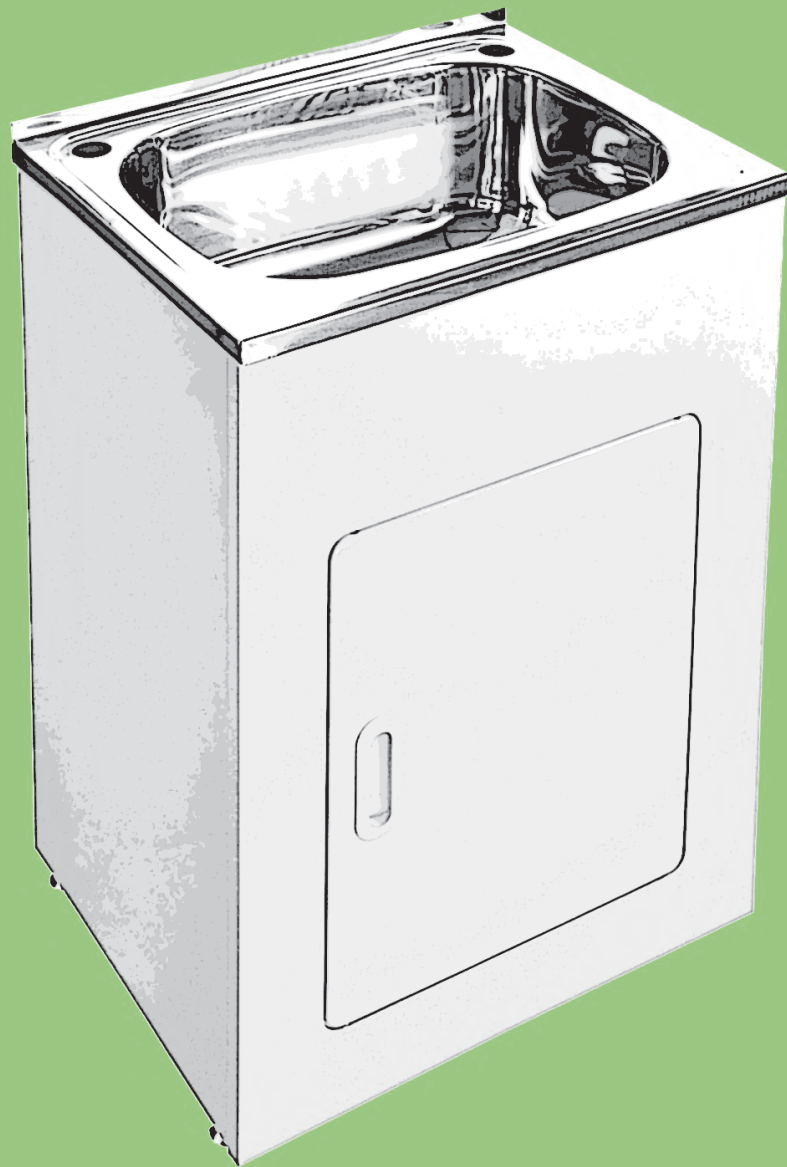

www.uniquehomeproducts.com.au

unique
home products

About Us

Unique Home Products is still a family owned and operated business run by father, Frank Mincone and family.

Frank established the business in 1981 as one of the original distributors of the 'mixer' style of tapware at the time.

Unique, formally known as 'Mamoli Australia' first started off in the business as a small wholesaler of mixers in the industry, 30 years on we now have more than 450 product lines.

At Unique we have positioned ourselves as a stand out competitor in our market with top quality products at a competitive price.

Our product range consists of

Sinks • Laundry Tubs • Mixers • Tapware • Basins • Toilets
Baths • Showerbases • Bathroom Accessories • Wastes
Hoses • Cleaning Agents • and lots more still to come..

We have a great sales network Australia Wide, ready to serve you.

Yakka

Laundry Inset Tub Collection

Tubs available in standard or compact

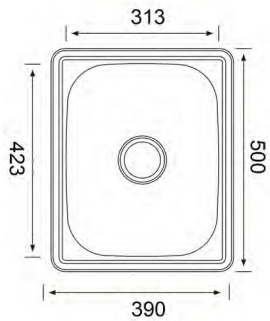

30 Litre



- 30 litre single inset tub
- 500mm x 390mm (Tub Size)
- Comes with or without tap hole
- Smooth Rounded Corners
- Bypass and Waste included

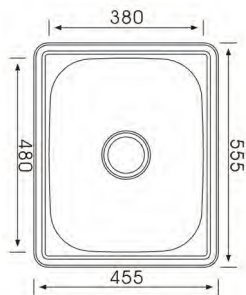

35 Litre



- 35 litre single inset tub
- 555mm x 455mm (Tub Size)
- Comes with or without tap hole
- Smooth Rounded Corners
- Bypass and Waste included

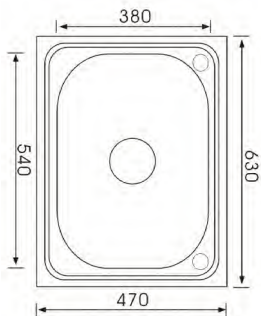

45 Litre



- 45 litre single inset tub
- 630mm x 470mm (Tub Size)
- Comes with or without tap hole
- Smooth Rounded Corners
- Bypass and Waste included

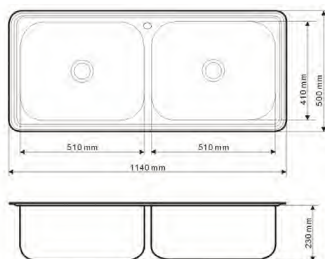

Double 45 Litre Tub



- Double Bowl inset tub
- 1140 x 500 (Tub Size)
- Comes with or without tap hole
- Bypass and Waste included

Yakka

Laundry Tub & Cabinet Collection

unique
home products



30 Litre Tub & Cabinet

- 30 litre single tub with colorbond[®] cabinet
- 390mm x 500mm x 455mm (Cabinet & Tub Size)
- 0.8 Stainless Steel thickness
- 18/8 Stainless Steel grade
- Comes with waste and bypass kit
- Comes with or without tap hole

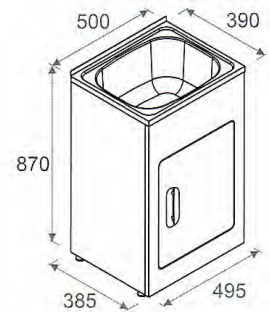

35 Litre Tub & Cabinet

- 35 litre single tub with Colorbond[®] cabinet
- 455mm x 555mm x 870mm (Cabinet & Tub Size)
- 0.8 Stainless Steel thickness
- 18/8 Stainless Steel grade
- Comes with waste and bypass kit
- Comes with or without tap hole

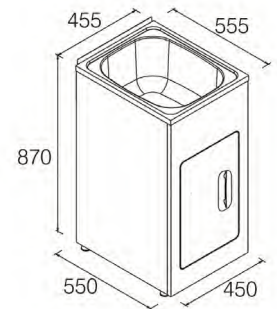

45 Litre Tub & Cabinet

- 45 litre single tub with colorbond[®] cabinet
- 470mm x 630mm x 870mm (Cabinet & Tub Size)
- 0.8 Stainless Steel thickness
- 18/8 Stainless Steel grade
- Comes with waste and bypass kit
- Comes with or without tap hole

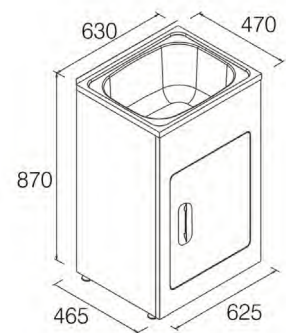

Double 45 Litre Tub & Cabinet

- 45 litre double tub with colorbond[®] cabinet
- 500mm x 1160 x 870mm (Cabinet & Tub Size)
- 0.8 Stainless Steel thickness
- 18/8 Stainless Steel grade
- Comes with or without tap hole
- Comes with waste and bypass kit
- Comes with or without tap hole

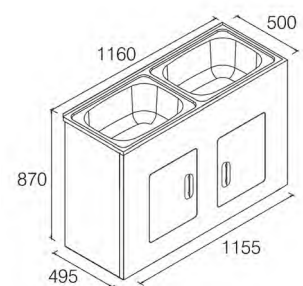

Yakka

Laundry Tub & Cabinet Collection

45 Litre Tub & Timber Cabinet

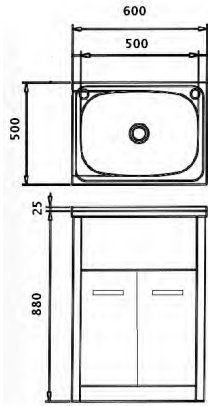

- 45 litre tub with gloss white timber cabinet
- 600mm x 500mm x 880mm (Tub & cabinet size)
- 0.8 stainless steel thickness
- 18/8 stainless steel grade
- Bypass and Waste included

Double 45 Litre Tub & Timber Cabinet

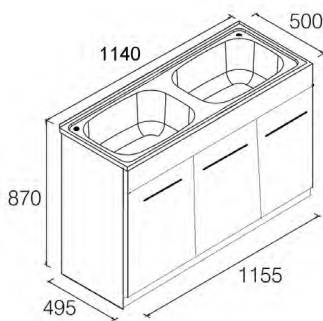

- Double 45 litre tub with gloss white timber cabinet
- 1140mm x 500mm x 870mm (Tub & cabinet size)
- 0.8 stainless steel thickness
- 18/8 stainless steel grade
- Bypass and Waste included

Compliment your laundry with some of our other products....

unique
home products



490 Inset Sink

Great for:

- Bars
- Commercial restaurants
- Cafés
- Hospitals

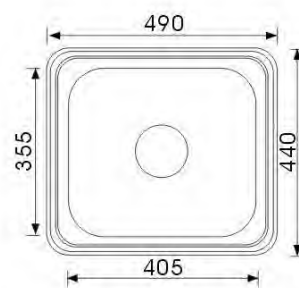

Cleaner Sink

Great for:

- Bars
- Commercial restaurants
- Cafés
- Hospitals

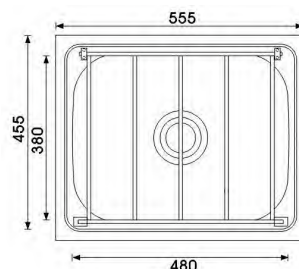

Washing Machine Tapware



Mixers



Wall Sink Sets

For more information on our other products, please refer to our other catalogues, or contact us.

Stainless Steel Care

Here at Unique we pride ourselves on delivering the best quality service and product to our consumer, therefore only sourcing the finest quality Korean/Japanese stainless steel sinks which is known as the best in the world.

The attractive and hygienic properties of stainless steel unfortunately cannot be regarded as maintenance free, all stainless steel scratches, especially in the bowls of the sinks because that's where most of the work is done. The stainless steel of the sinks has been polished for the consumer to either have a shiny or a matte finish, so it makes it easier to see scratches.

This does not mean that your sink scratches easy, however with quality stainless steel these scratches caused by usage will develop until a uniform finish over time.

To reduce the amount of scratching and enhance the life and appearance of your sink we recommend the following:

- Rinse thoroughly after each use, rubbing the area with a soft sponge.
- Towel dry after each use to prevent mineral deposits in the water from building up on the surface of the sink.
- Food preparation - Food and ingredients such as raw meat (especially salted), undiluted fruit juices (especially lemon) and spicy sausages may cause slight staining.
- Don't allow liquid soap or cleanser to dry on the surface of the sink as most cleaning agents contain chemicals that can affect the high luster of the sink.
- Don't leave solutions of chlorine bleach or chlorides found in many dishwasher soap products, standing in your sink for long periods of time, as this could damage the surface of the sink.
- Don't use a steel wool pad to clean your sink. If a more abrasive product is needed, use a mild liquid cleanser being sure not to rub too hard as this may cause scratching in the direction you are rubbing. Steel wool pads will leave small particles of steel embedded in the surface of the sink that will rust and give the appearance that the sink itself is rusting.
- If you use a rubber mat or basin protector while washing dishes, remember to remove them after each use. Bacteria can grow under these protectors if allowed to remain in the basin.
- Don't leave bars of soap, wet sponges or cleaning pads on the sink. These items over time will dull and possibly pit the surface of the finish.
- Don't leave fruits or juices on the sink; wipe them up immediately as they contain citric acids which over time can etch the surface.
- Avoid contact of the stainless steel with any harmful liquids...These include acids and chemicals such as pool chlorine, battery acid, muriatic acid, solvents, glues and paint removers.

All our stainless steel products are:

- .304 grade
- 18/10 or 18/8
- Corrosion Resistant
- Easy to clean

At Unique there is no compromise when it comes to delivering the best quality possible.

Unique offer an outstanding 25 year replacement warranty on all stainless steel products, to ensure the best quality and service.

Agents/ Distributors

Victoria (Head Office)

Unique Home Products

5 Milkman Way,
Coburg North, Vic, 3058
Phone: (03) 9354 3744
Fax: (03) 9354 3755
Email: sales@uniquehomeproducts.com.au

Queensland

Moody & Winter Sales

15 Boron Street,
Sumner Park, QLD 4074
Sales Phone: (07) 3376 2455
Sales Fax: (07) 3376 5415

New South Wales

Rogers Industries

Dubbo

6 Richard Ryan Place
Dubbo, NSW 2830
Sales Phone: (02) 6882 2733
Sales Fax: (02) 6882 2733
Sales Email: sales@rogersindustries.com

Albury

592 Dallinger Road
Lavington, NSW 2641
Sales Phone: (02) 6882 2733
Sales Fax: (02) 6882 2733
Sales Email: sales@rogersindustries.com

ACT

Canberra

42 Raws Crescent
Hume, ACT 2620
Sales Phone: (02) 6882 2733
Sales Fax: (02) 6882 2733
Sales Email: sales@rogersindustries.com

South Australia

Unique Home Products

5 Milkman Way
Coburg North, Vic 3058
Phone: (03) 9354 3744
Fax: (03) 9354 3755
Email: sales@uniquehomeproducts.com.au

Tasmania

Unique Home Products

5 Milkman Way
Coburg North, Vic 3058
Phone: (03) 9354 3744
Fax: (03) 9354 3755
Email: sales@uniquehomeproducts.com.au

Western Australia

Unique Home Products

5 Milkman Way
Coburg North, Vic 3058
Phone: (03) 9354 3744
Fax: (03) 9354 3755
Email: sales@uniquehomeproducts.com.au



Your Local Distributor



All pictures are for illustration purposes only.

All our products comply to Watermark and WELS scheme where applicable.

Please note: All dimensions given should be checked prior to installation.